

PLAN

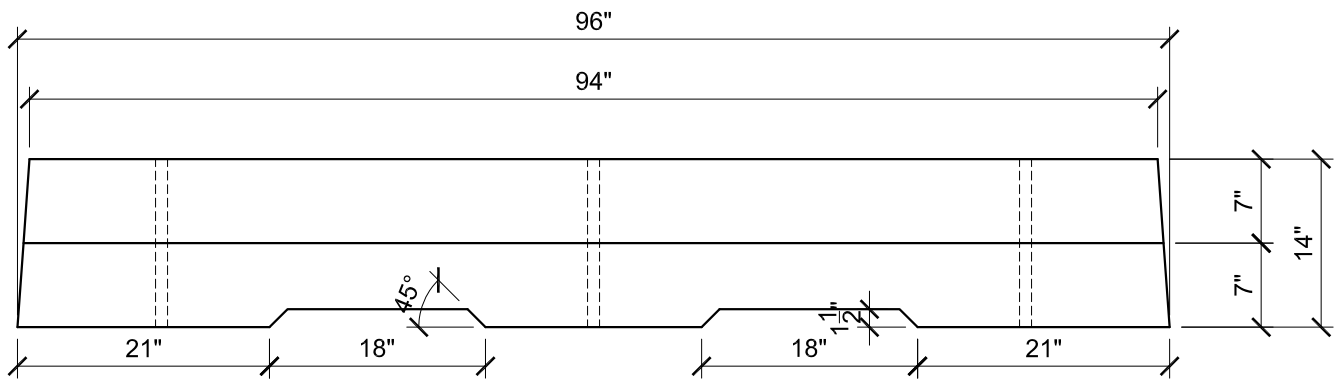

ELEVATION

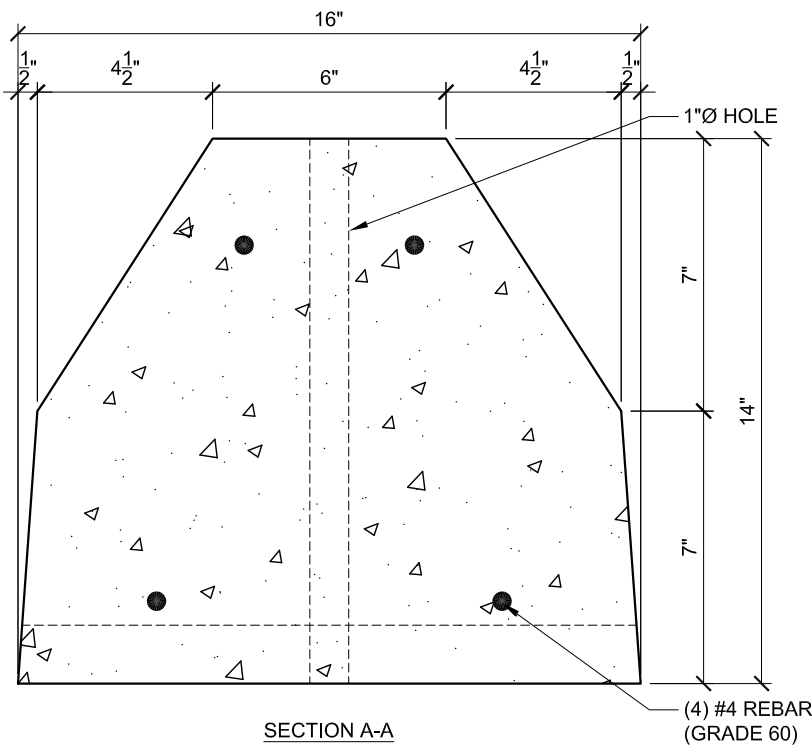

SECTION A-A

(4) #4 REBAR
(GRADE 60)

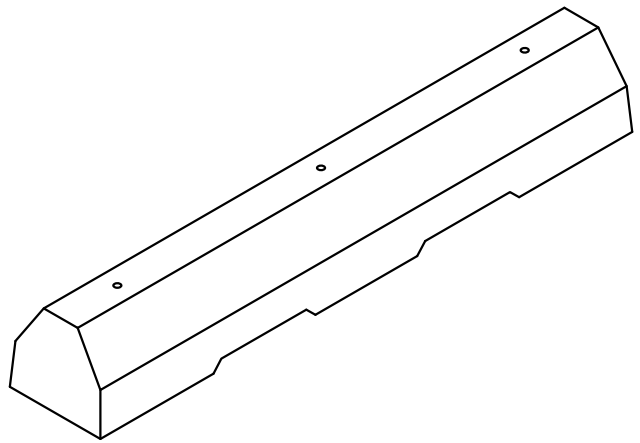

NOTES: 5500 PSI Air Entrained Concrete 1,300 lbs

TMega Truck Parking Curb



7 South Kinzer Rd. Ph: 717.442.CURB (2872)
 PO Box 132 Fax: 717.442.4873
 Kinzers, PA 17535 Web: www.curboparkingcurbs.com

DRAWING #: TMega

DRAWN BY: CWW

DATE: 04/12/19

REVISED:

BY: